

HYGOFRESH 3000

Luftfrischer



Verbrauchsmaterial

70.050/M Duftdose Mint
70.050/P Duftdose Peach
70.050/W Duftdose Water Fresh
40.112 Batterie LR20

Elektronischer Luftfrischer

Der HYGOFRESH 3000 Luftfrischer beseitigt und verhindert unangenehme Gerüche und garantiert angenehme Luft rund um die Uhr.

- LCD-Anzeige
- Echtzeitprogrammierung mittels eingebauter Uhr
- Einstellbare Sprüh-Intensität, Beginn und Dauer sowie Wochentage
- Einfache Montage/Installation
- Gehäuse aus robustem ABS-Kunststoff
- Batteriebetrieben (2x LR20)
- Sehr geringer Batterieverbrauch
- Anzeige des Batterieladezustandes
- FCKW-freie (Fluorchlorkohlenwasserstoff) Spray Dosen
- Einfacher Austausch der Duftdosen

B/H/T 80 x 230 x 90 mm

Art-Nr. 70.055

Team-Nr. 574 041

ST-Nr. 4612 191

Lieferumfang:



Abmessungen

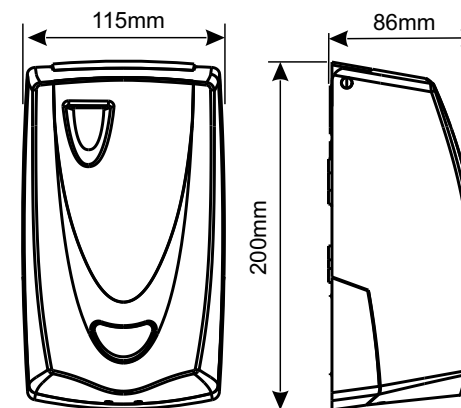

Batterie-Abdeckung

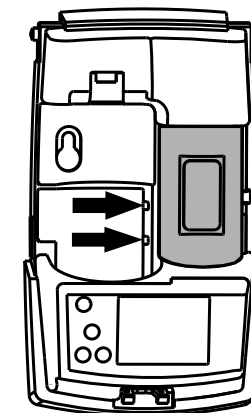

HYGOFRESH 3000

Appareil diffuseur de désodorisant



Appareil diffuseur de désodorisant automatique

Le désodorisant L'HYGOFRESH 3000 élimine et prévient les odeurs désagréables et garantit un air agréable 24 heures sur 24.

- Affichage LCD
- Programmation en temps réel au moyen d'une horloge intégrée
- Intensité, début et durée réglables
- Montage/installation simple
- Fonctionnement avec des piles (2 x LR20)
- Très faible consommation de piles
- Affichage de l'état de charge des piles
- Spray aérosols sans CFC (chlorofluorocarbone)
- Échange facile des spray

Produit avec offre de services [\(v. p. 3\)](#)

Consommables

70.050/M Spray Mint
70.050/P Spray Peach
70.050/W Spray Water Fresh
40.112 Pile LR20

L/H/P 80 x 230 x 90 mm

N° art. 70.055
N° Team 574 041
N° ST 4612 191

Contenu de la livraison :



Dimensions

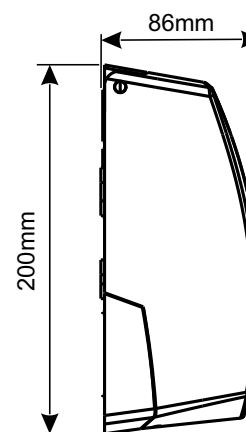
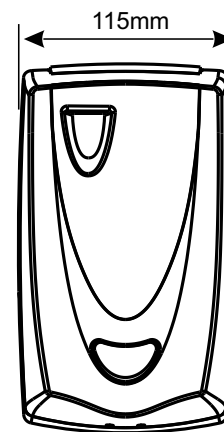

Couvercle de la batterie

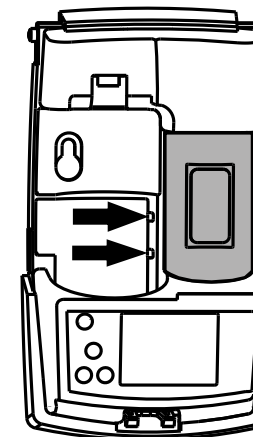

HYGOFRESH 3000

Air freshener



Consumables

- 70.050/M Spray Can Mint
- 70.050/P Spray Can Peach
- 70.050/W Spray Can Water Fresh
- 40.112 Battery LR20

Electronic Air Freshener

The HYGOFRESH 3000 Air Freshener eliminates and prevents unpleasant odors and guarantees pleasant air around the clock.

- LCD display
- Real-time programming by means of a built-in clock
- Adjustable spraying intensity, start and duration and weekdays
- Simple assembly/installation
- Housing made of robust ABS plastic
- Battery operated (2x LR20)
- Very low battery consumption
- Display of the battery charge level
- CFC-free (chlorofluorocarbon)
- Spray cans
- Fragrance cans are easy to exchange

W/H/D 80 x 230 x 90 mm

Part-No. 70.055

Team no. 574 041

Part no. 4612 191

Scope of delivery:



Dimensions

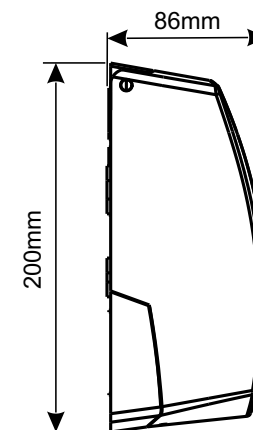
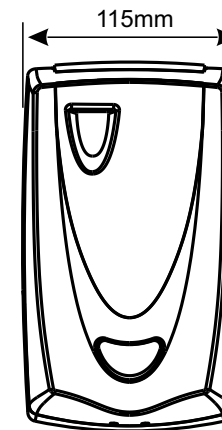

Battery Cover

